

HOW TO INSTALL A TRIMMER LINE

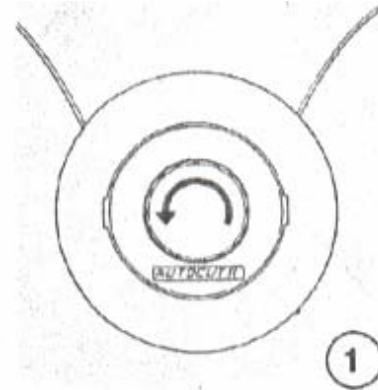

1

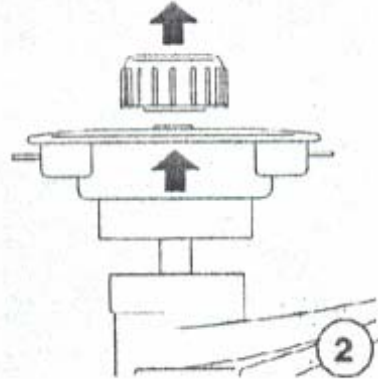

2

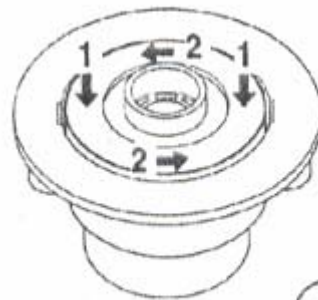

3

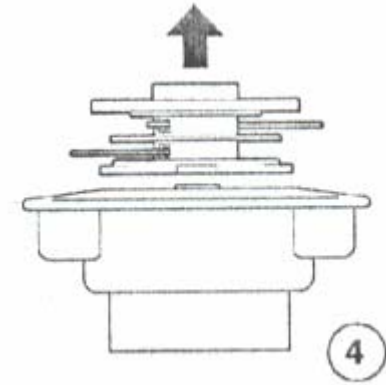

4

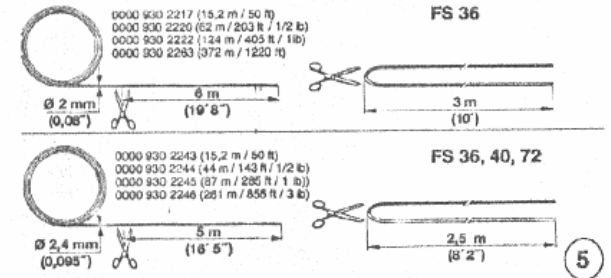

5

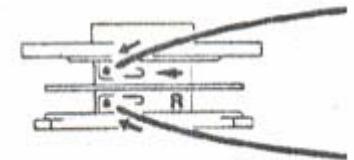

6

CLIFF'S

YOUR EQUIPMENT SPECIALIST

LAWN & GARDEN ICE AND SNOW CONTROL

488 MORDEN RD., OAKVILLE, ON L6K 3W4

Tel.: (905) 844-4304 ** Fax: (905) 844-4306

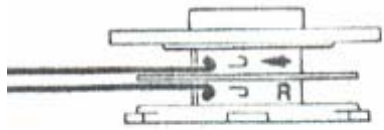

7

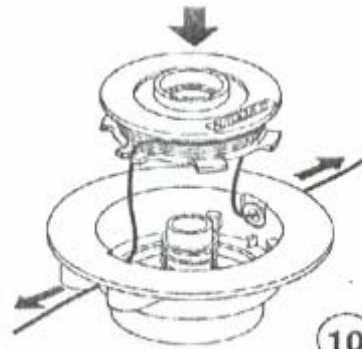

10

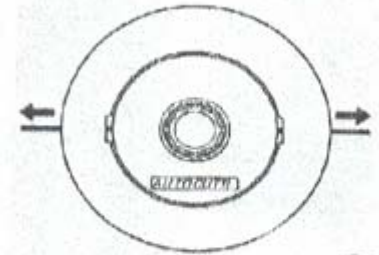

13



8

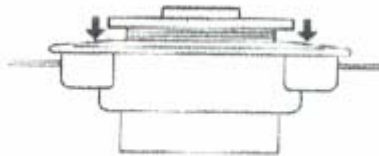

11

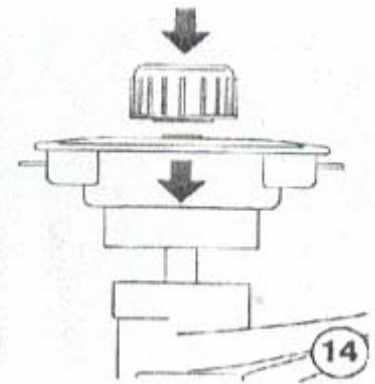

14

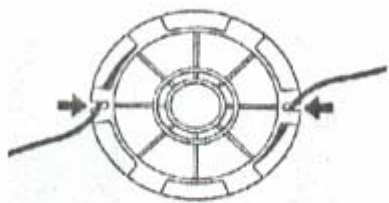

9

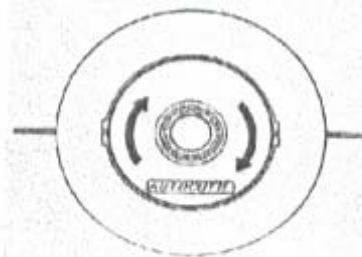

12

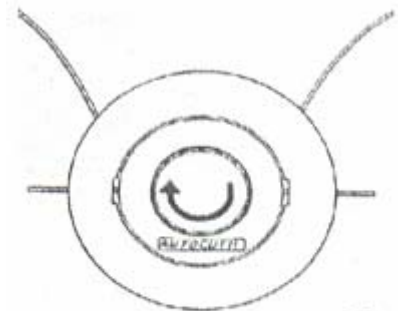

15